

DETAIL A

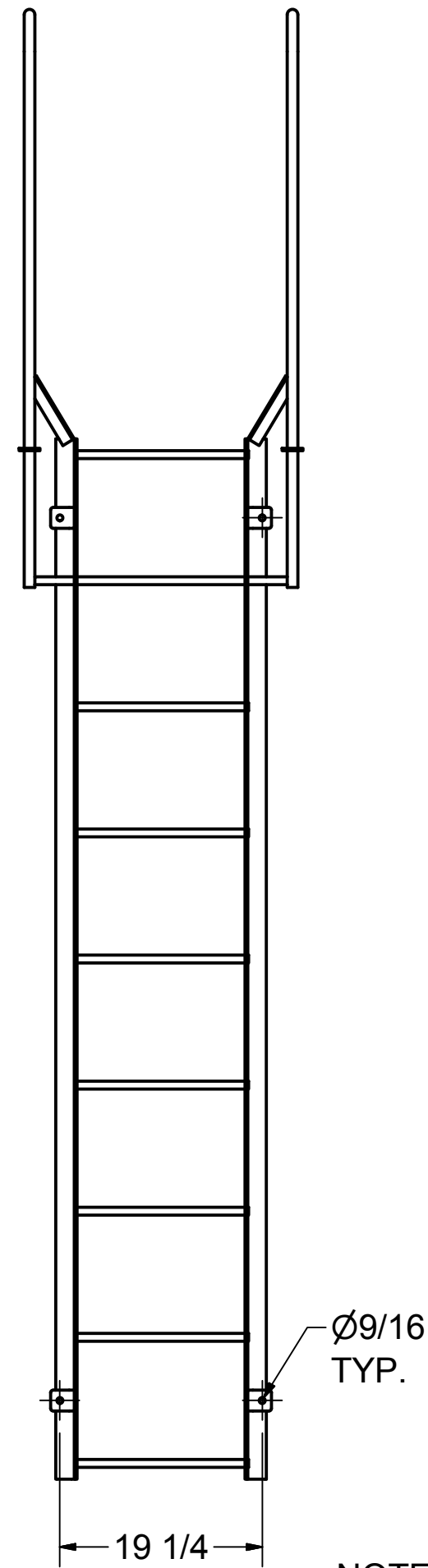

NOTE:
STANDOFF BRACKET LOCATIONS
ARE $\pm 1"$.
DO NOT PREDRILL HOLES IN THE
STRUCTURE.
HOLES SHOULD BE MATCH DRILLED
TO INSURE PROPER ALIGNMENT

3D MODEL AVAILABLE IN STEP FILE FORMAT ON OUR WEBSITE

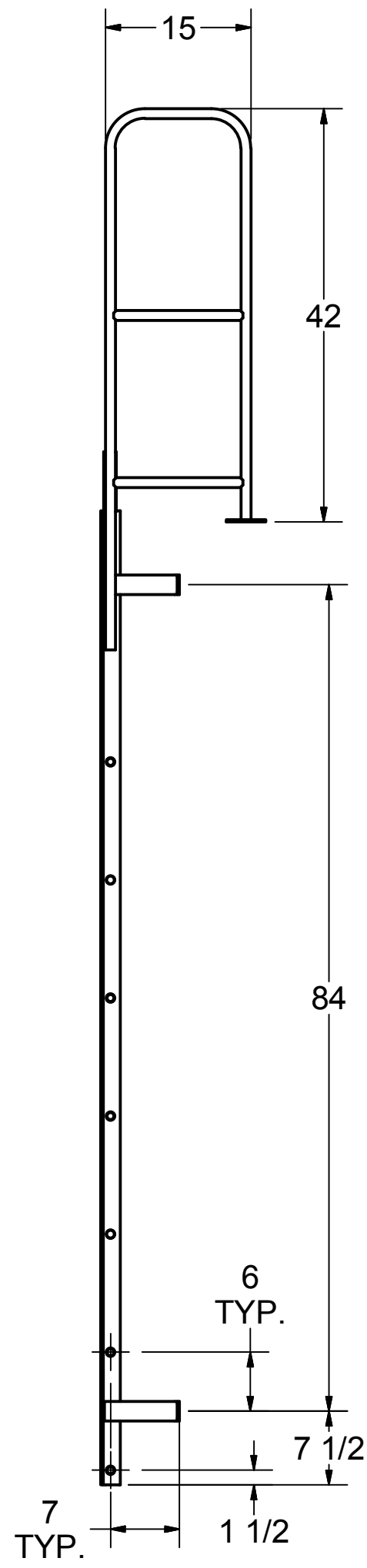
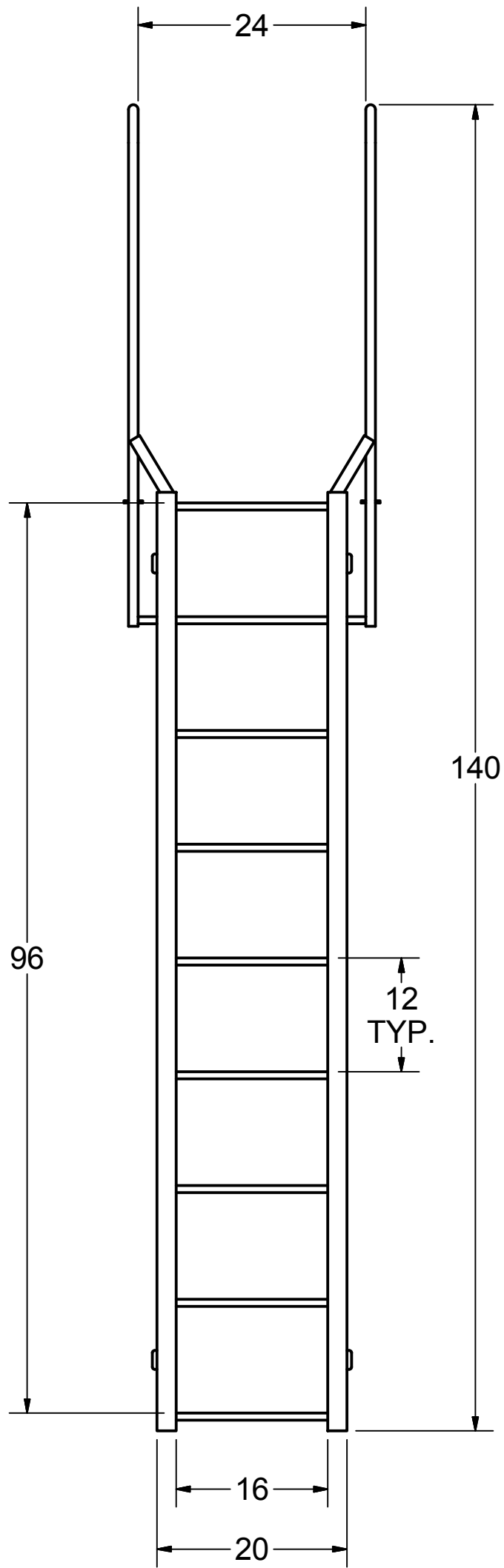

DRAWN KJS	7/2/2013		
CHECKED			
APPROVED		TITLE	
PART 3570227 F9W FOR CATALOG		F9W	
		Drawing is computer generated, and print might not be to scale	
SIZE C	DWG NO 3570227 F9W FOR CATALOG.dwg	REV A	
DIMENSIONS IN INCHES UNLESS NOTED			SHEET 1 OF 1