

DETAIL A

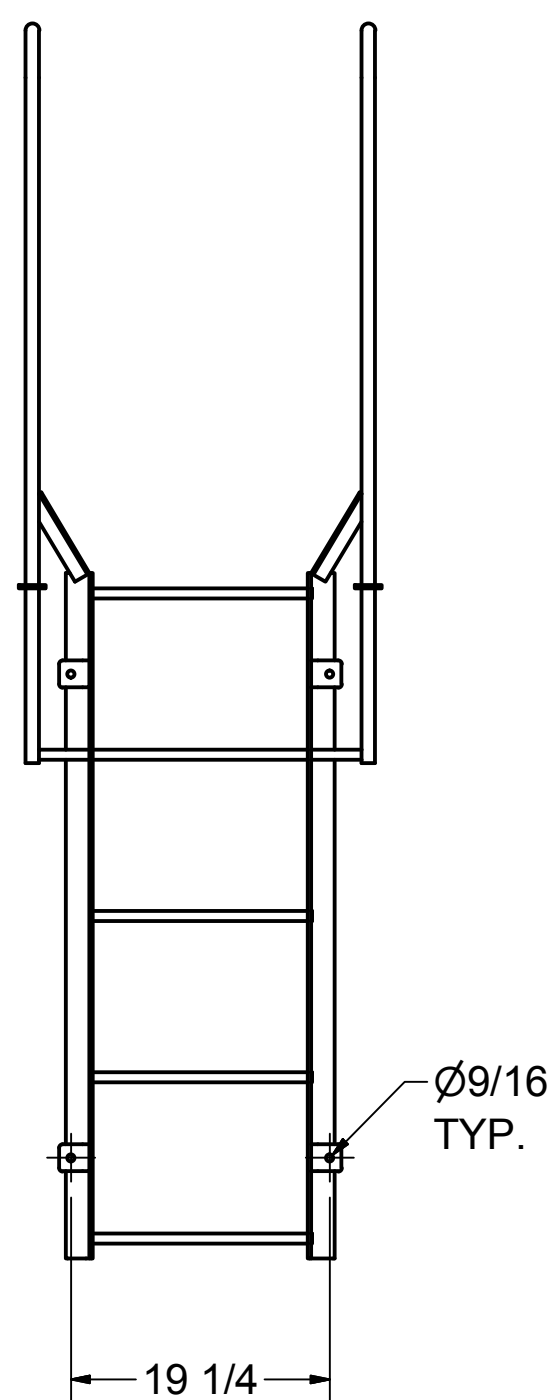

NOTE:
STANDOFF BRACKET LOCATIONS
ARE ± 1".
DO NOT PREDRILL HOLES IN THE
STRUCTURE.
HOLES SHOULD BE MATCH DRILLED
TO INSURE PROPER ALIGNMENT

3D MODEL AVAILABLE IN STEP FILE FORMAT ON OUR WEBSITE

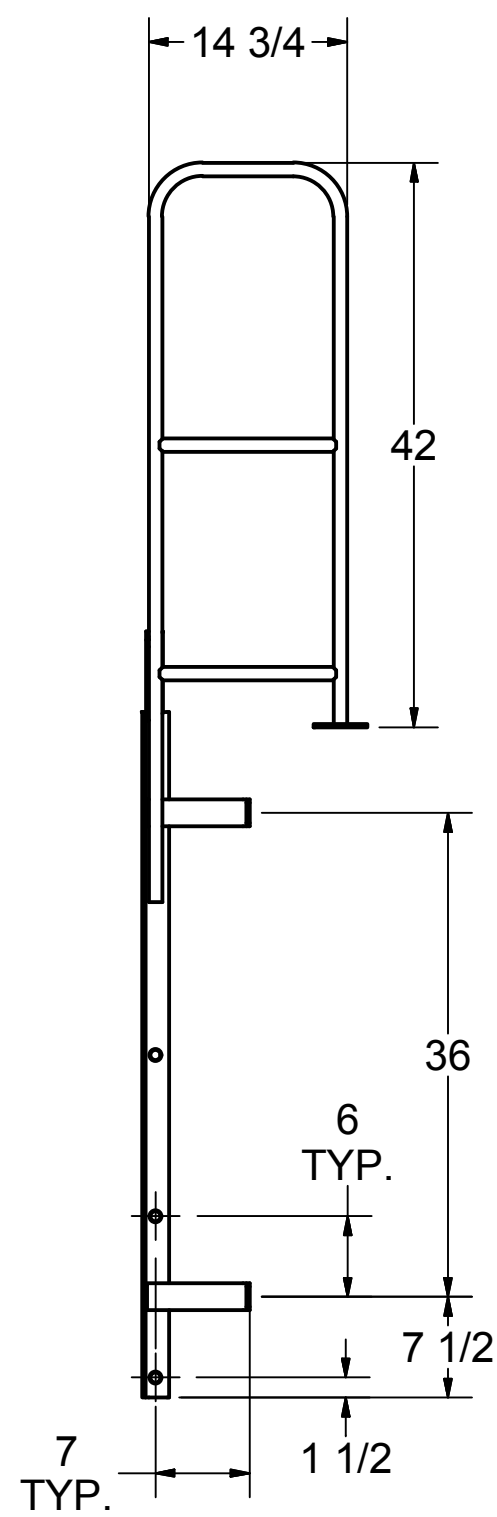
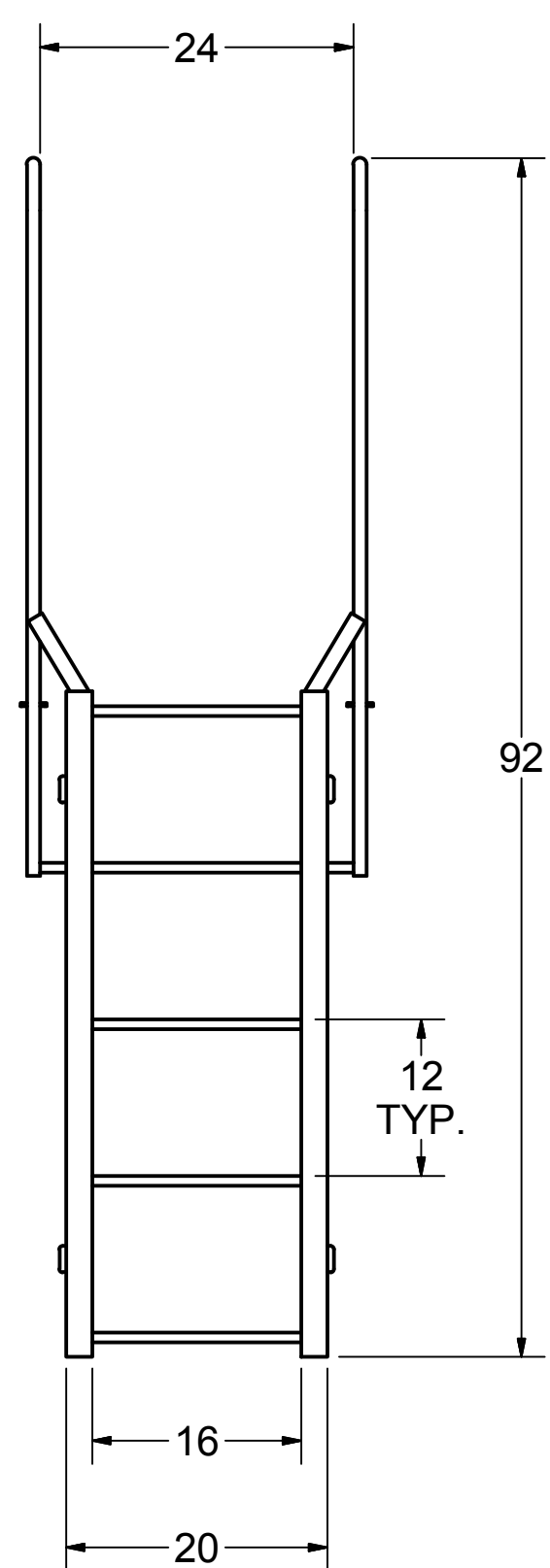
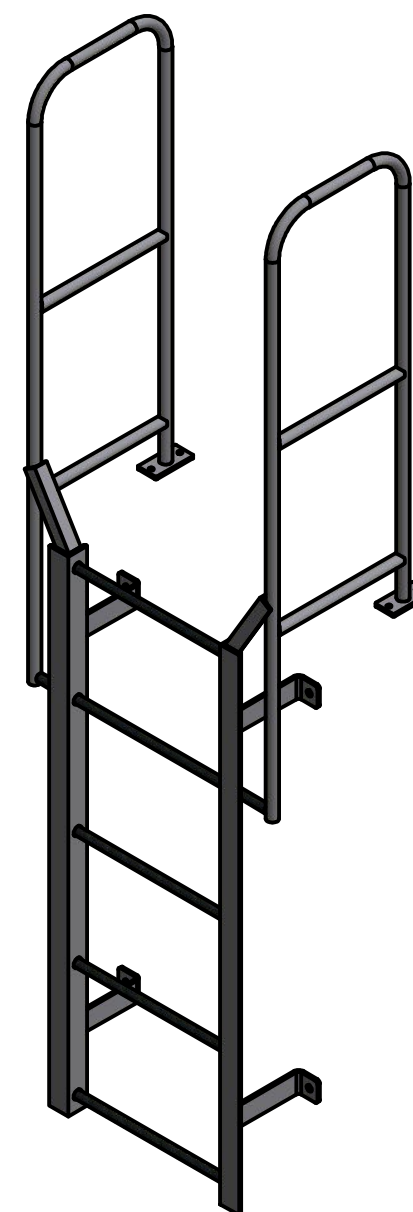

DRAWN KJS	7/2/2013		
CHECKED			
APPROVED		TITLE	
PART 3570223 F5W FOR CATALOG		F5W	
Drawing is computer generated, and print might not be to scale			
SIZE C	DWG NO 3570223 F5W FOR CATALOG.dwg	REV A	
DIMENSIONS IN INCHES UNLESS NOTED			SHEET 1 OF 1