

DETAIL A

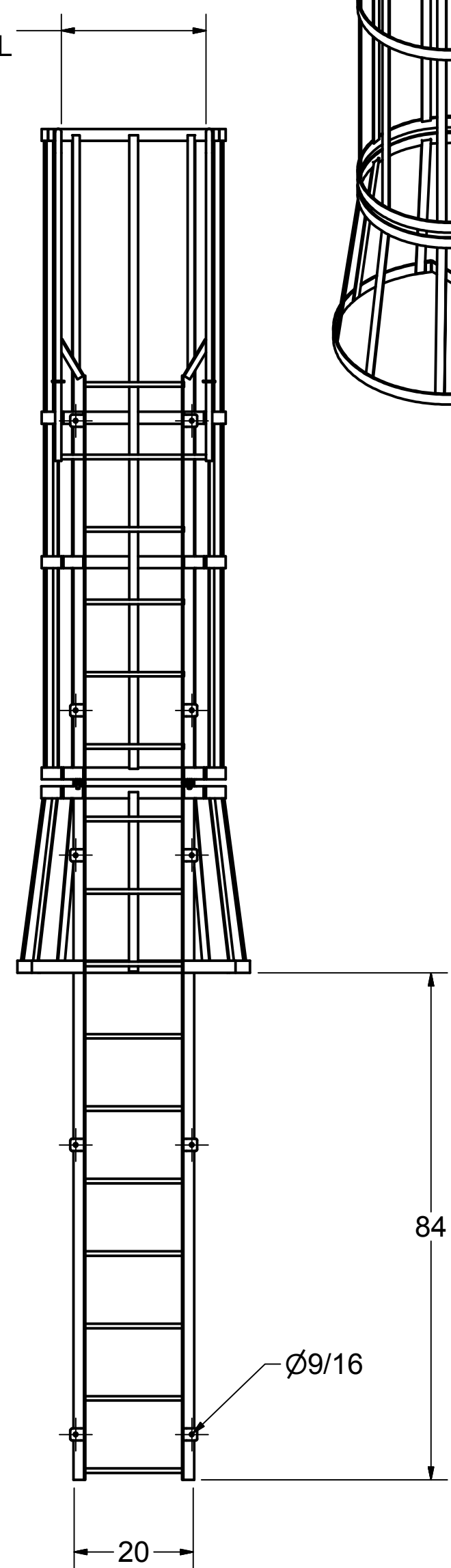
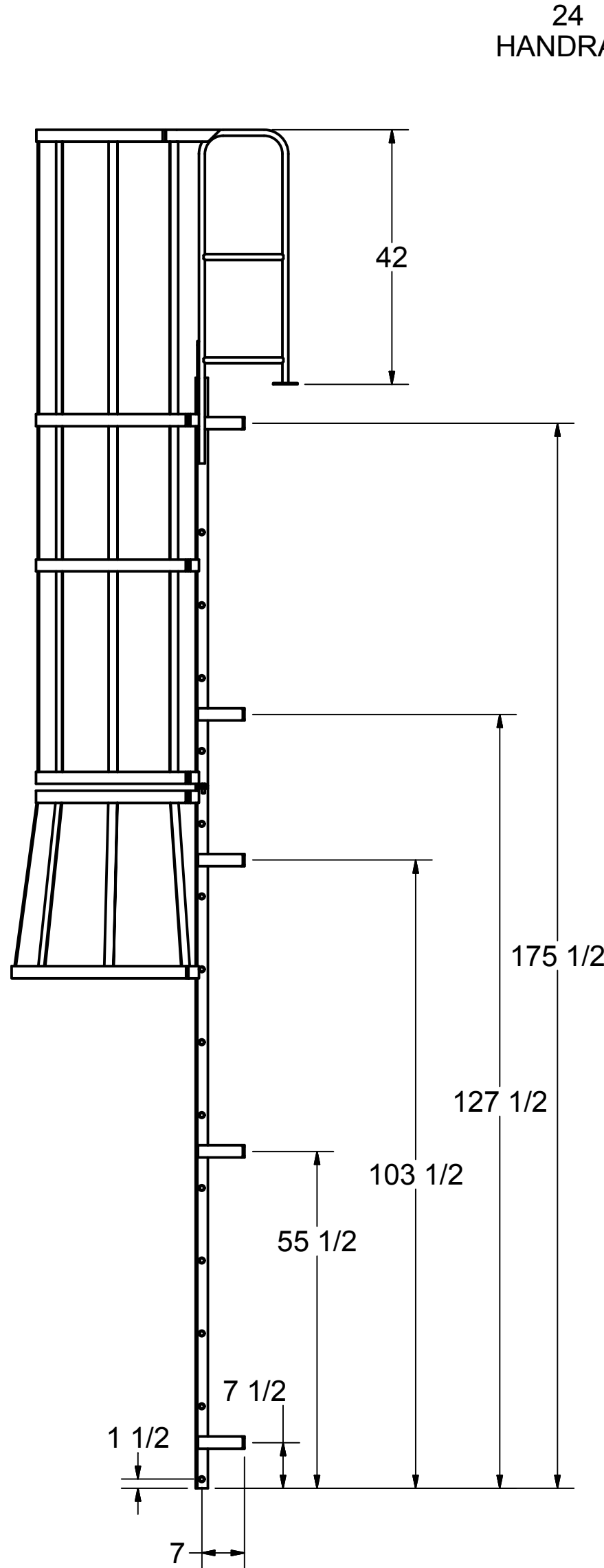
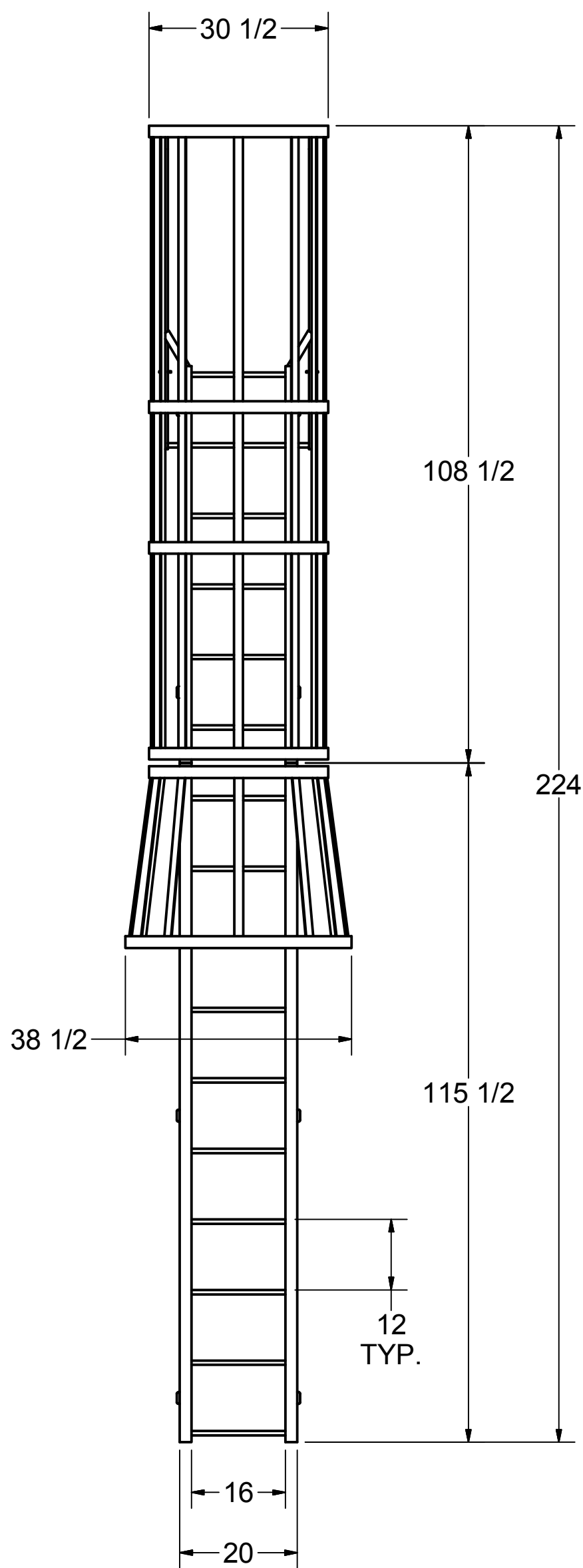
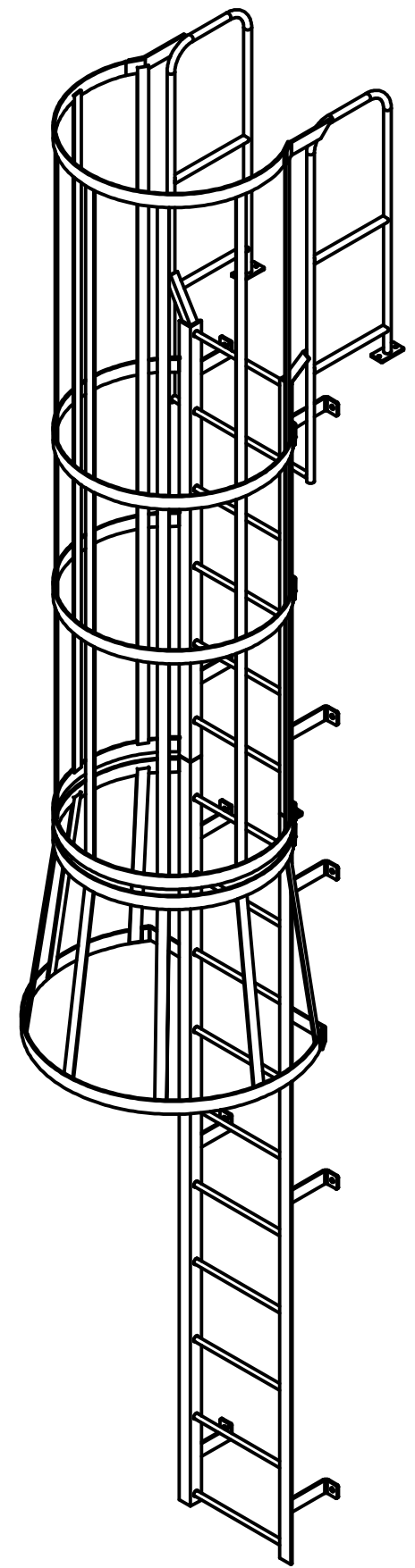

NOTE:
STANDOFF BRACKET LOCATIONS

ARE +/- 1"

DO NOT PREDRILL HOLES IN THE STRUCTURE.
HOLES SHOULD BE MATCH DRILLED TO INSURE
PROPER ALIGNMENT.

3D MODEL AVAILABLE IN STEP FILE FORMAT ON OUR WEBSITE

DRAWN NA	6/25/2018		
CHECKED			
APPROVED		TITLE	
PART D0570196-02 F16WC FOR CATALOG		F16WC	
		Drawing is computer generated, and print might not be to scale	
SIZE	DWG NO	REV	
C	D0570196-02 F16WC FOR CATALOG.dwg	A	
DIMENSIONS IN INCHES UNLESS NOTED			SHEET 1 OF 1