

DETAIL A

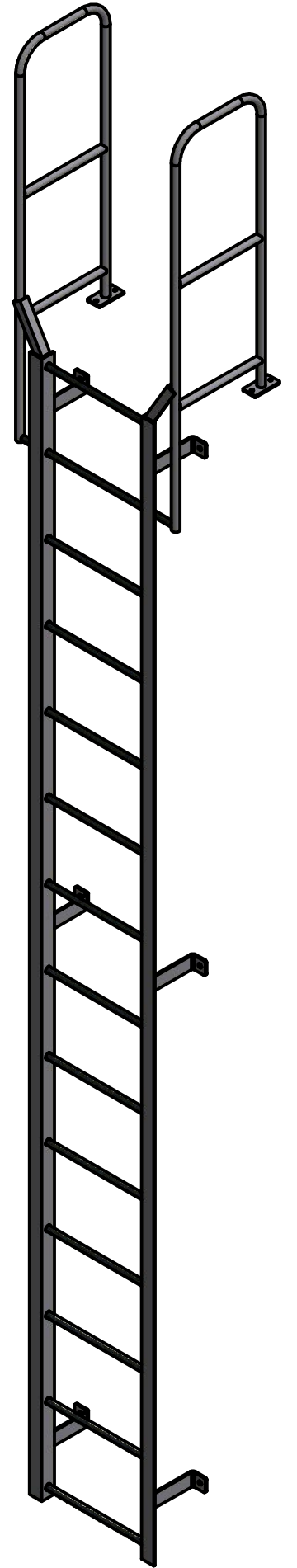

NOTE:
STANDOFF BRACKET LOCATIONS
ARE ± 1".
DO NOT PREDRILL HOLES IN THE
STRUCTURE.
HOLES SHOULD BE MATCH DRILLED
TO INSURE PROPER ALIGNMENT

3D MODEL AVAILABLE IN STEP FILE FORMAT ON OUR WEBSITE

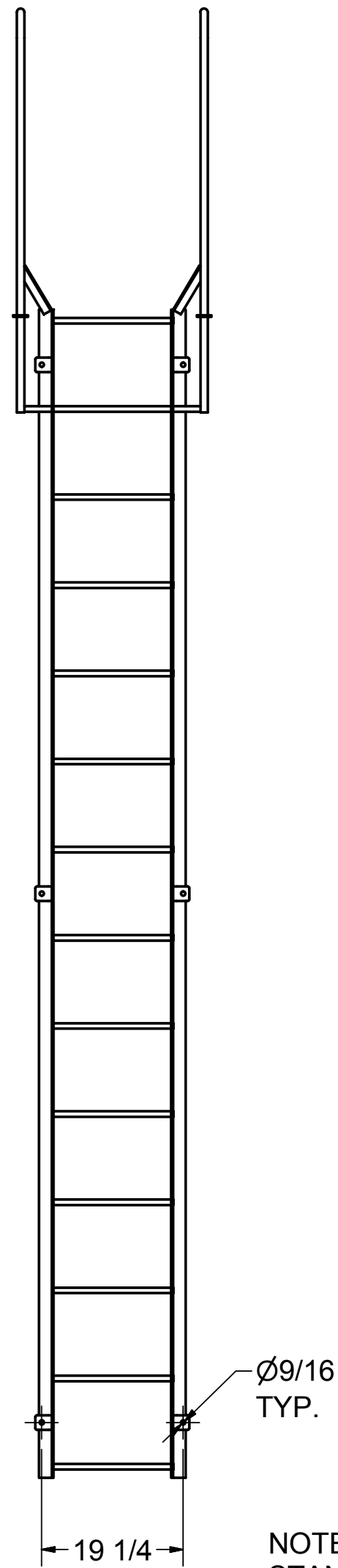
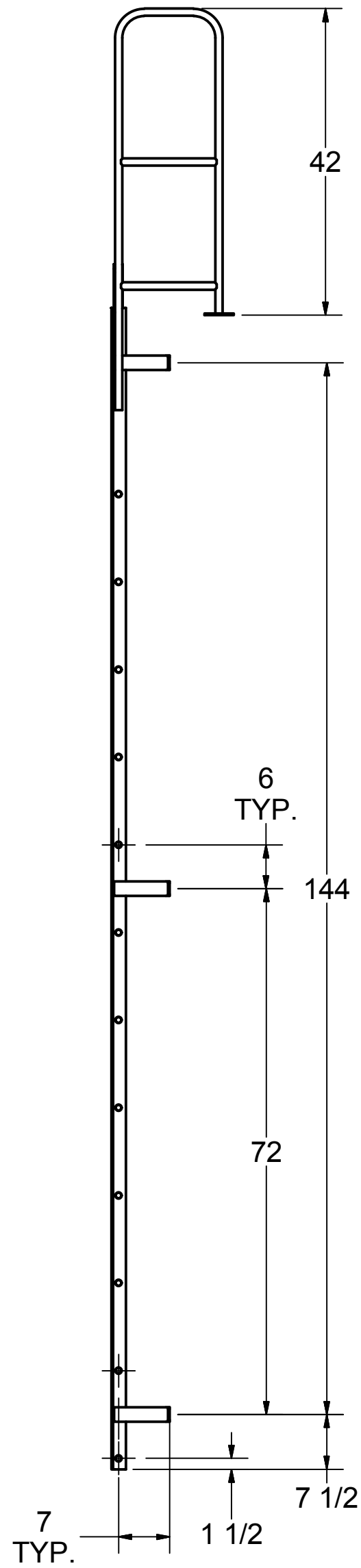
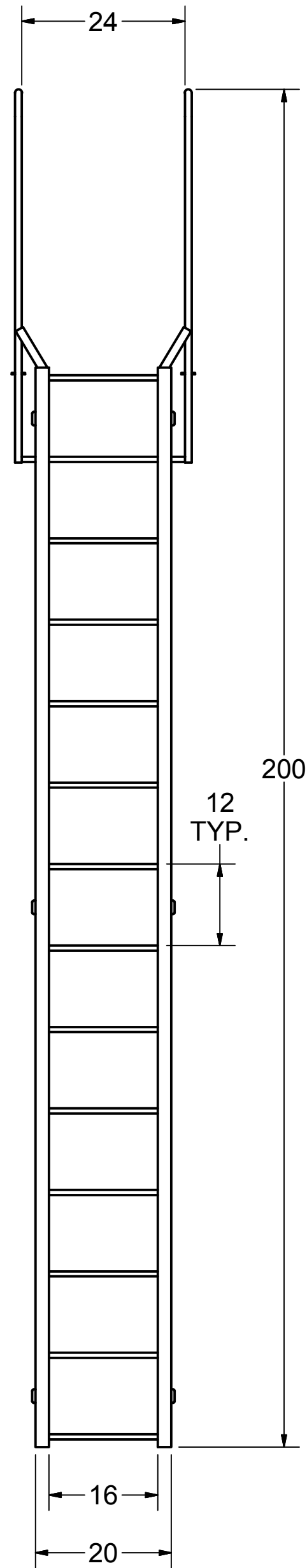

DRAWN KJS	12/4/2017		
CHECKED		TITLE	
APPROVED		F14W	
PART 3570232 F14W FOR CATALOG		Drawing is computer generated, and print might not be to scale	
		SIZE C	DWG NO 3570232 F14W FOR CATALOG.dwg
			REV A
DIMENSIONS IN INCHES UNLESS NOTED			SHEET 1 OF 1